

Spare Parts Price List

Comfort 220

Comfort 250 B

Comfort 252

Valid from 01.12.2002

Terms of payment:
Prices are in Euro, ex works ex VAT.
Freight, postage and costs for packaging will be added to the price.

Payment:
2 % discount for payment in 10 days
or within 30 days net .

This list supercedes and invalidates
all previous dealer price lists.

Spare Parts View of Motor Unit Comfort 220

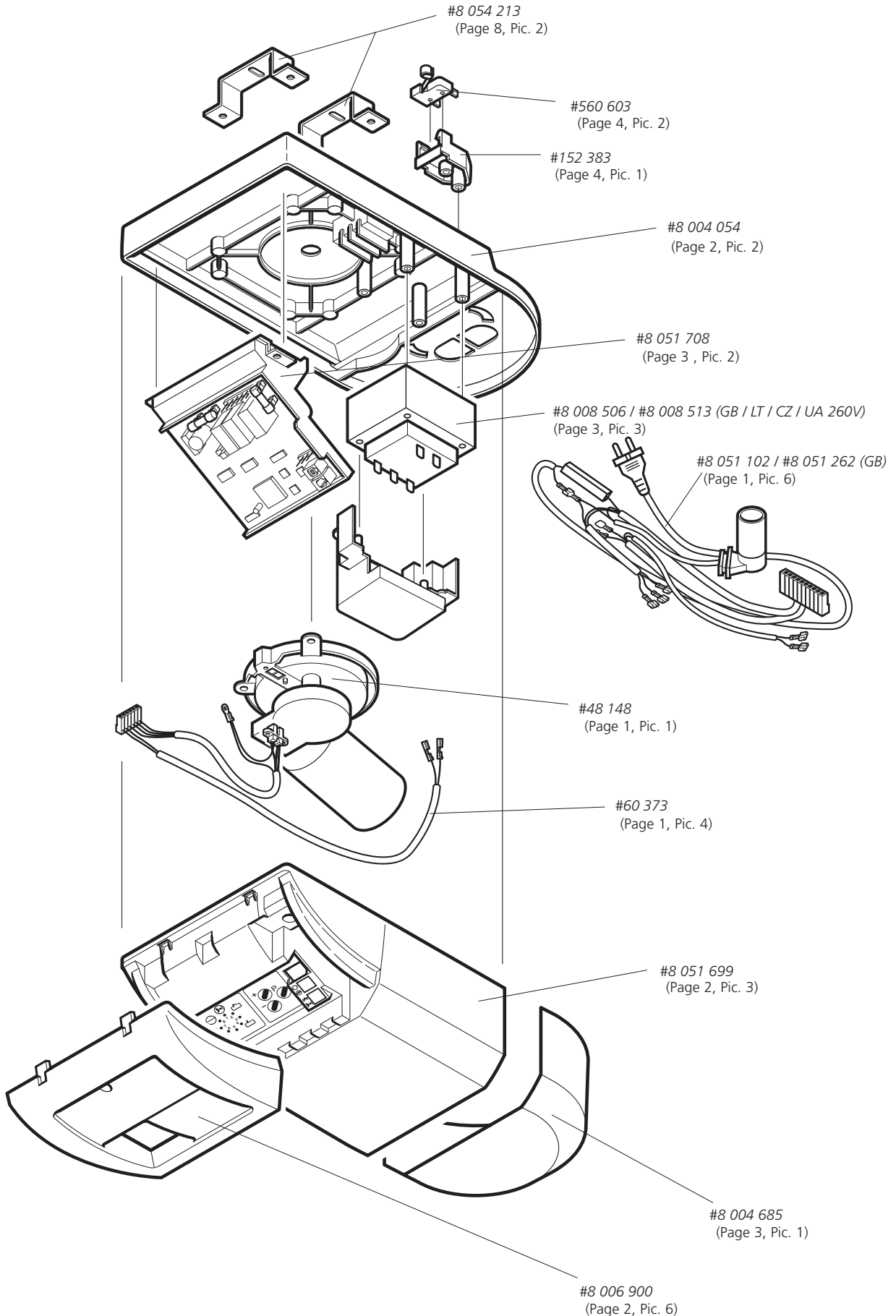

Spare Parts View of Motor Unit Comfort 250B

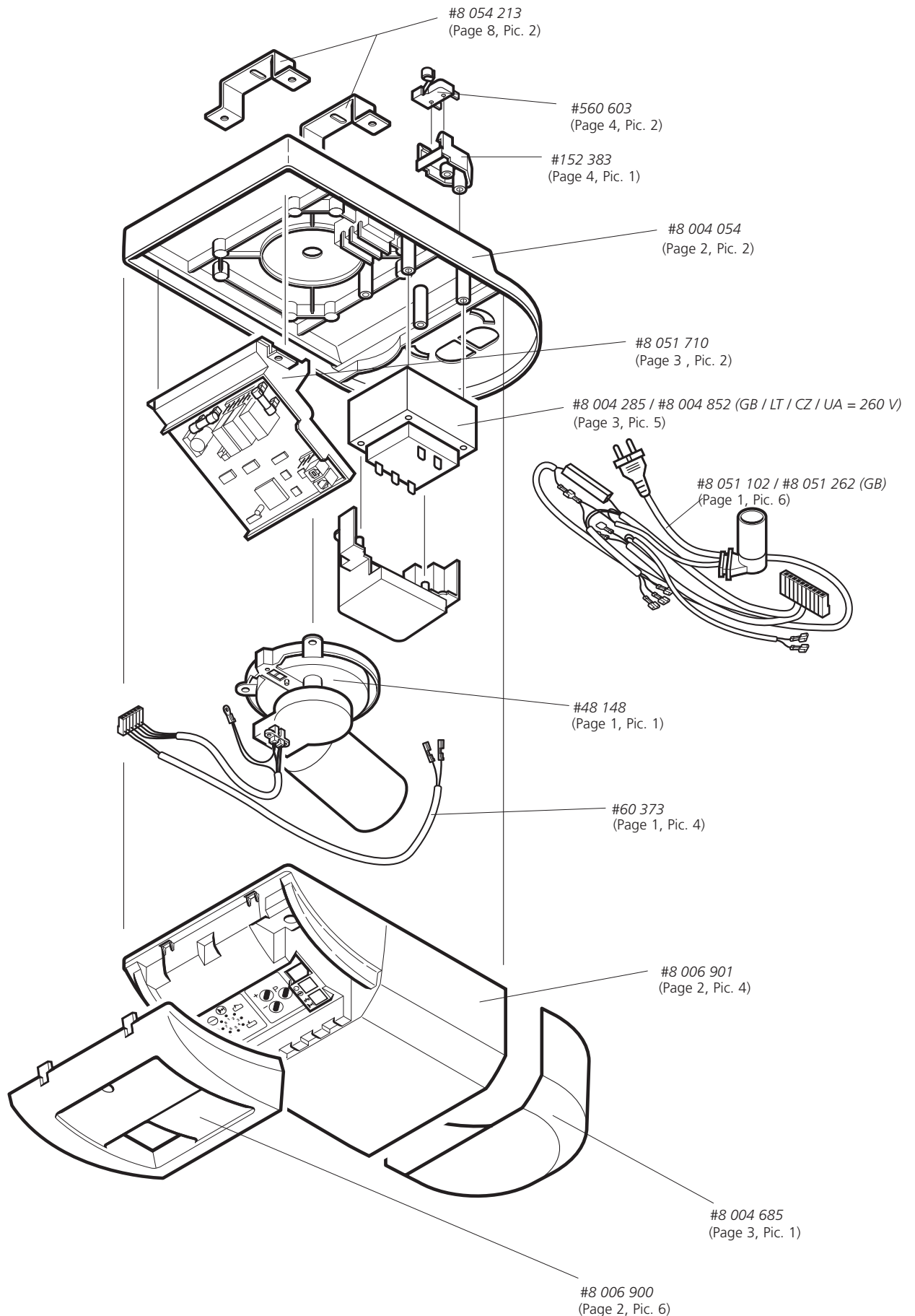



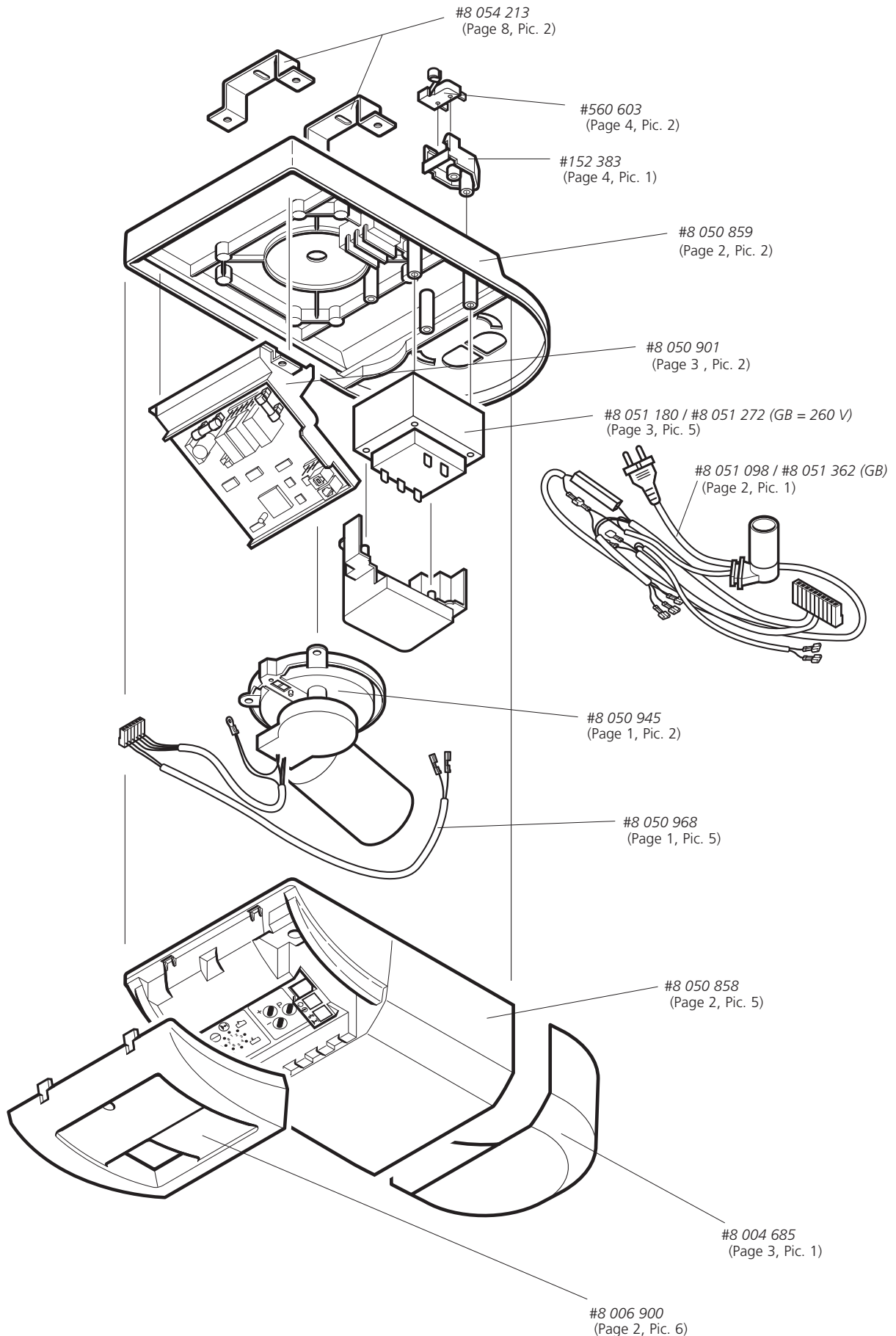

Spare Parts View of Motor Unit Comfort 252

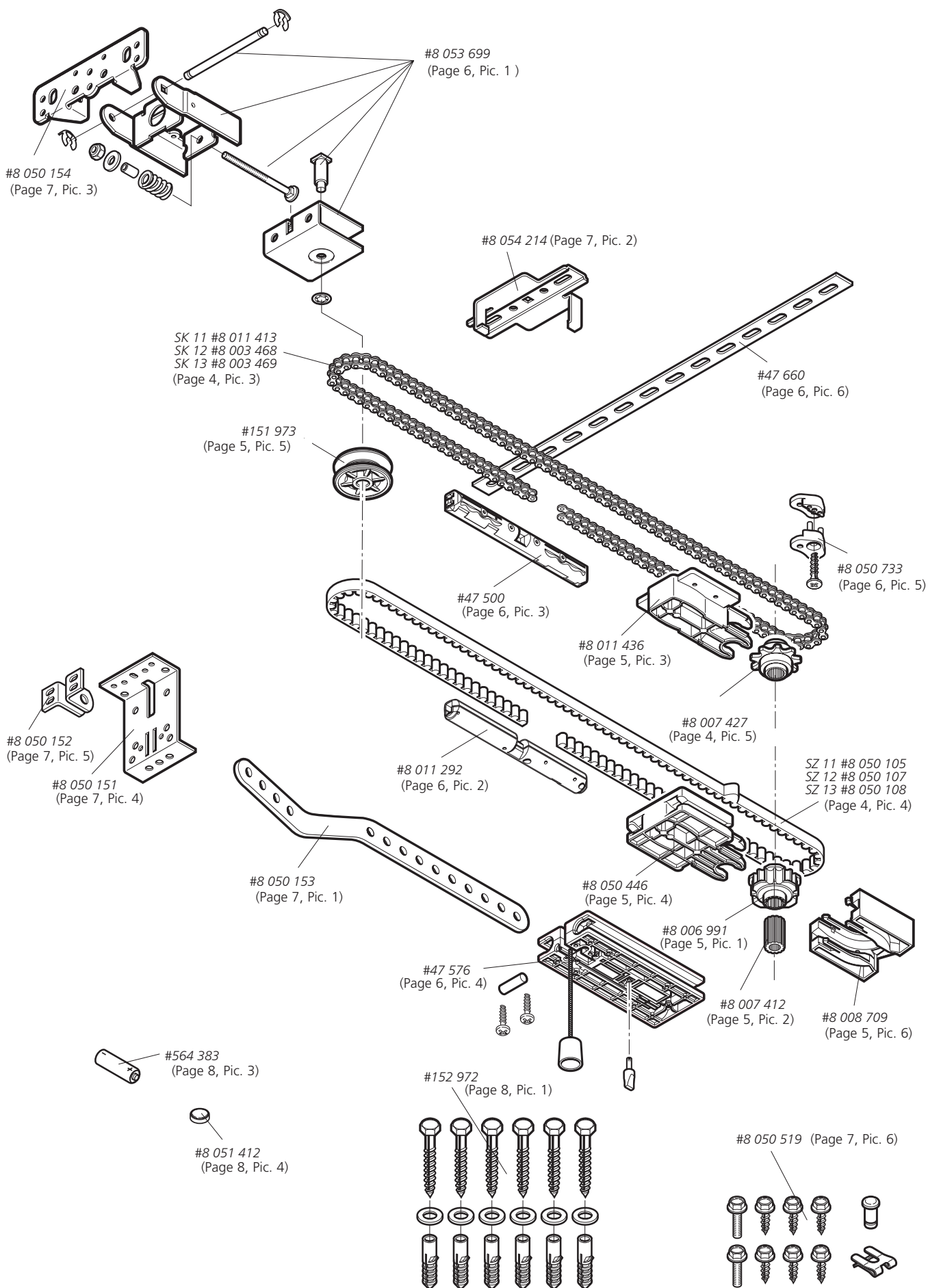

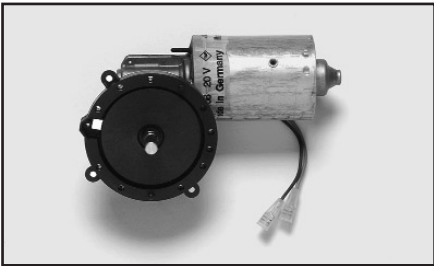
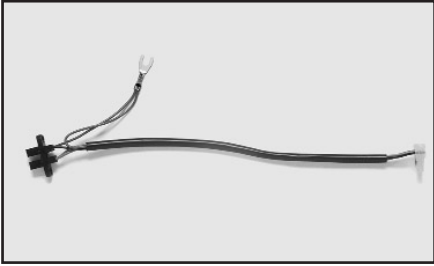
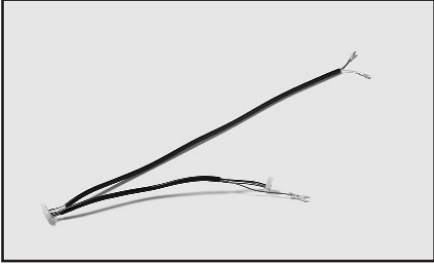



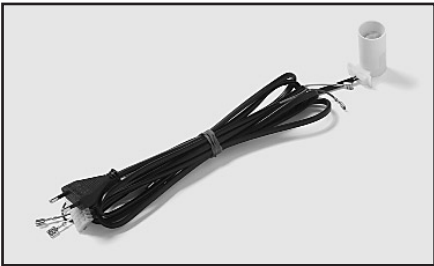
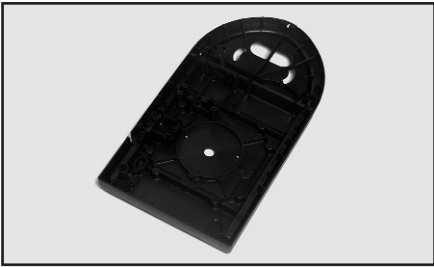
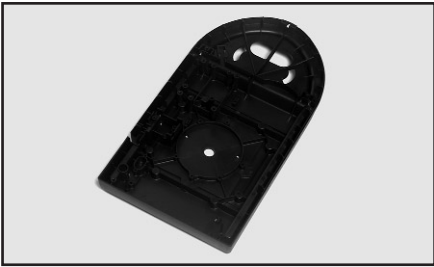
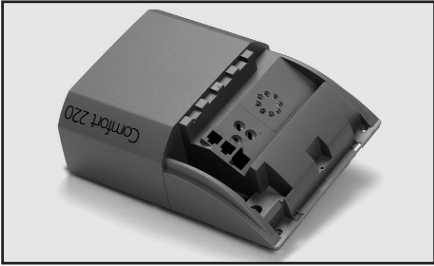
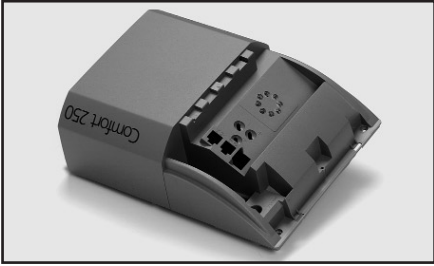



Spare Parts View of Rail - Comfort 220/250B/252







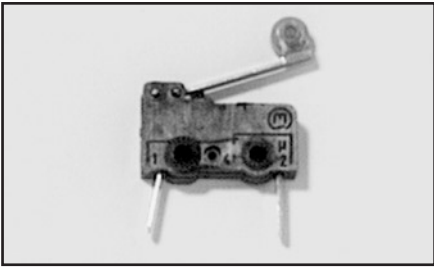

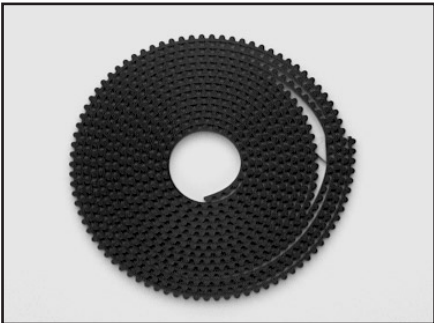
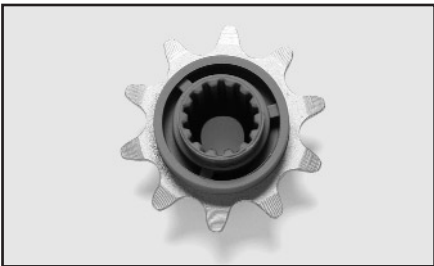

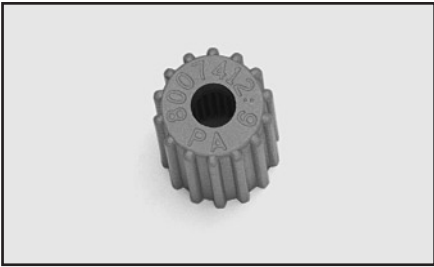
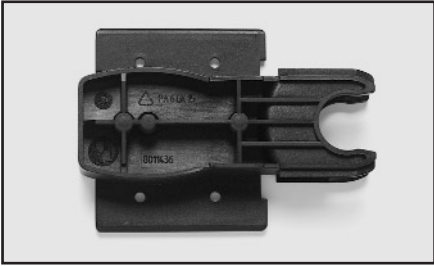
	Item	Comfort			Item-No	Price each
		220	250B	252		
	DC Operator motor	x	x		48 148	€ 85,00
	DC Operator motor			x	8 050 945	€ 127,00
	Cable Reference point sensor 3-part-set until 12.2001	x	x		60 581	€ 33,00
	Cable Reference point sensor 4-pole from 01.2002	x	x		60 373	€ 17,00
	Cable Reference point sensor			x	8 050 968	€ 14,00
	Cable Motor	x	x		8 051 102	€ 29,00



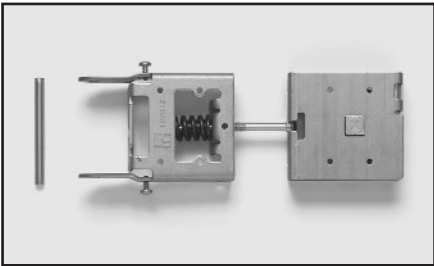
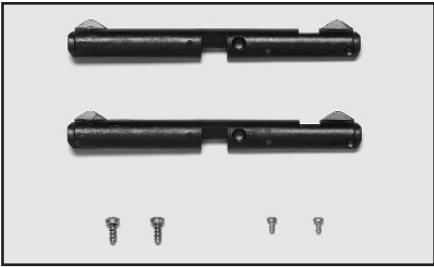

	Item	Comfort			Item-No	Price each	
		220	250B	252		€	
	Cable Motor			x	8 051 098	€	29,00
	Drive chassis	x	x		8 004 054	€	22,00
	Drive chassis			x	8 050 859	€	33,00
	Drive cover Comfort 220	x			8 051 699	€	20,00
	Drive cover Comfort 250B		x		8 006 901	€	20,00
	Drive cover Comfort 252			x	8 050 858	€	20,00
	Drive panel	x	x	x	8 006 900	€	12,00

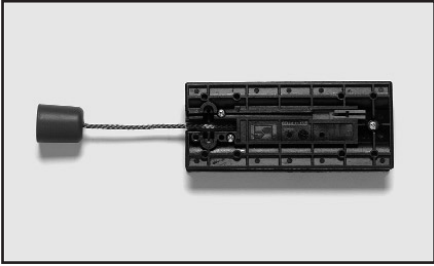

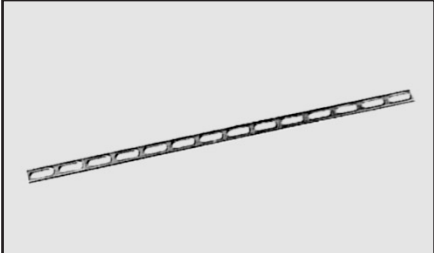
	Item	Comfort			Item-No	Price each	
		220	250B	252			
	Lamp cover	x	x	x	8 004 685	€	10,00
	Circuit board holder Comfort 220 Incl. circuit board	x			8 051 708	€	127,00
	Circuit board holder Comfort 250B Incl. circuit board		x		8 051 710	€	150,00
	Circuit board holder Comfort 252 Incl. circuit board			x	8 050 901	€	174,00
	Transformer EI66/36 230V/24V/7A	x			8 008 506	€	34,00
	Transformer EI84 240V/22V/10A		x		8 004 285	€	50,00
	Transformer EI84/29,5 230V/18V/14A			x	8 051 180	€	60,00

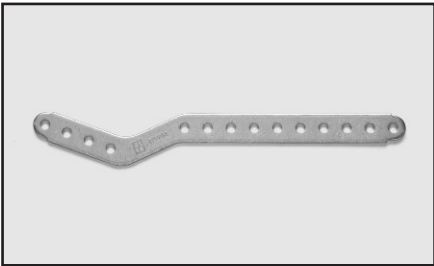
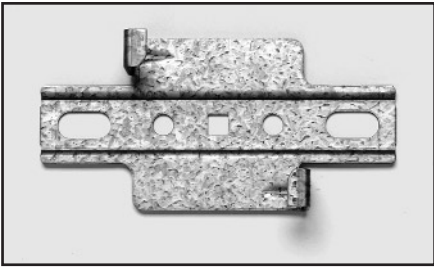
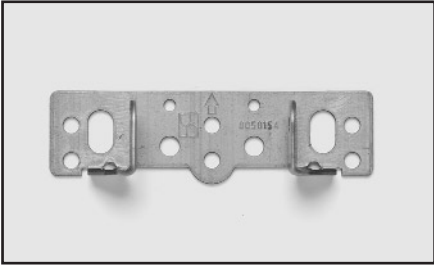
	Item	Comfort			Item-No	Price each	
		220	250B	252		€	
	Housing for micro switch	x	x	x	152 383	€	4,00
	Micro switch reference point	x	x	x	560 603	€	8,00
	Roller chain SK 11	x	x	x	8 011 413	€	31,00
	Roller chain SK 12	x	x	x	8 003 468	€	33,00
	Roller chain SK 13	x	x	x	8 003 469	€	43,00
	Toothed drive belt SZ 11	x	x	x	8 050 105	€	59,00
	Toothed drive belt SZ 12	x	x	x	8 050 107	€	65,00
	Toothed drive belt SZ 13	x	x	x	8 050 108	€	75,00
	Driven sprocket 10 teeth (Roller chain)	x	x	x	8 007 427	€	14,00

	Item	Comfort			Item-No	Price each	
		220	250B	252		€	
	Driven toothed disc (toothed drive belt)	x	x	x	8 006 991	€	6,00
	Adaptor/spacer	x	x	x	8 007 412	€	1,00
	Sprocket support (roller chain)	x	x	x	8 011 436	€	4,00
	Drive wheel fork (toothed drive belt)	x	x	x	8 050 446	€	4,00
	Reflection roller (toothed drive belt / roller chain)	x	x	x	151 973	€	4,00
	Guide bearing	x	x	x	8 008 709	€	13,00

Item	Comfort			Item-No	Price each	
	220	250B	252		€	
	x	x	x	8 053 699	€	13,00
	x	x	x	8 011 292	€	7,00
	x	x	x	47 500	€	4,00
	x	x	x	47 576	€	16,00
	x	x	x	8 050 733	€	2,00
	x	x	x	47 660	€	4,00

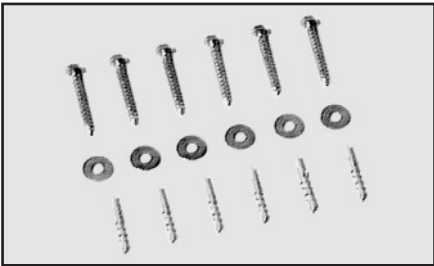
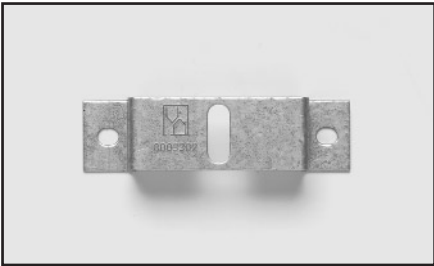
Item	Comfort			Item-No	Price each	
	220	250B	252		€	
 <p>Door link cranked</p>	x	x	x	8 050 153	€	7,00
 <p>Suspension clip for C boom</p>	x	x	x	8 054 214	€	5,00
 <p>Lintel bracket (for C operator boom version valid from 01/1999)</p>	x	x	x	8 050 154	€	4,00
 <p>Door connector element</p>	x	x	x	8 050 151	€	4,00
 <p>Door link bracket</p>	x	x	x	8 050 152	€	2,00
 <p>Set of screws for up-and-over door</p>	x	x	x	8 050 519	€	6,00

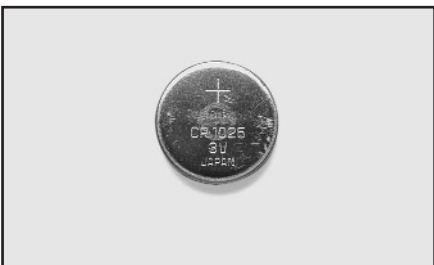
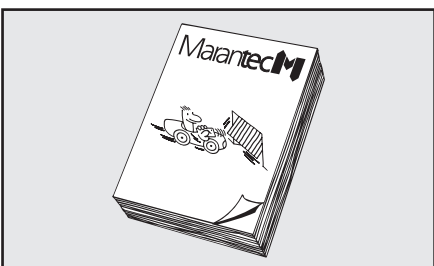
Item	Comfort			Item-No	Price each	
	220	250B	252			
 <p>Plug and screw fixing set for C-boom Plastic plug U 10 Wood screws 8x60</p>	x	x	x	152 972	€	6,00
 <p>Clamp strap</p>	x	x	x	8 054 213	€	3,00
 <p>Battery for Digital 211 - 214 for Digital 221 - 224</p>	x	x	x	564 383	€	5,00
 <p>Battery for Digital 231 / 232</p>		x	x	8 051 412	€	2,00
 <p>Installation and Operating Instructions</p> <p>Comfort 220 Illustration manual Text manual GB</p> <p>Comfort 250B Illustration manual Text manual GB</p> <p>Comfort 252 Illustration manual Text manual GB</p>	x x			8 051 700 8 051 671	€ €	0,00 0,00
		x x		8 050 988/A 8 050 991/A	€ €	0,00 0,00
			x x	8 050 990/A 8 050 993/A	€ €	0,00 0,00

Sales Conditions and Terms of Delivery

A. General standard terms and conditions

I. Conclusions

1. Our offers are without engagement. All conclusions and changes thereof are only binding after written confirmation.
2. These conditions are also applicable to future delivery and/or services. We contradict to divergent conditions of the customer.
3. With products being manufactured separately on order, the contract is considered to be concluded after our written confirmation, even if there still have to be given clarifications which may have an influence on delivery period and price.
4. We reserve to ourselves sole ownership and copyright to all documents (pictures, drawings, descriptions, etc.) belonging to the offer, a transmission of these documents to third parties – even in extracts – is only admissible after prior written consent.
5. The given information in our informative documents is subject to alterations.
6. We are entitled to partial deliveries.

II. Prices

1. Prices are ex works or ex stock plus the correspondent applicable value added tax (also for interest on defaulted payment). Freight and packaging in Euro. We only grant you a discount for payment in cash. This discount does also require the punctual fulfilment of all of the buyer's duties, also of those of earlier sales. We do not grant a discount on wage-invoice-costs.
2. We are entitled to charge you subsequently for all increases in costs occurred after conclusion of the contract (costs for material, wage, energy, legal regulations, etc.)

III. Payments

1. At a price below Euro 5,000.00, payment has to be effected within 30 days from date of invoice. At a price of more than Euro 5,000.00, one third has to be paid with receipt of the written confirmation of the order, another third after receipt of the information of the readiness to deliver, the last third 30 days after date of invoice, these payments have each to be effected in cash notwithstanding the right of the customer's complaint under exclusion of a contested counter-claim and the right to refuse performance as independently from the execution of possibly effected assembly services as well. The price for assembly indicated in the invoice has to be paid immediately after termination of assembly.
2. Bills of exchange are only accepted for payment and due to special agreement. Credit notes on bills of exchange and cheques are only given under the reservation of receipt less all expenses with value date of the day, on which we can dispose of the equivalent.
3. We charge you with interests according to the corresponding bank discount rates for short-term credits in case of any overrun of time for payment, at least however we charge you with interests of an amount of 3 % over the corresponding discount rate of the Deutsche Bundesbank.
4. Our claims are due at once - independently from the life span of bills of exchange that have been taken in or have been credited – if the terms of payment are not respected by the customer or if we get to know information being suitable to diminish the customer's creditworthiness. Regardless of other legal rights we are also entitled, to carry out outstanding deliveries and/or services against payment in advance or safety services. We may also - without cancellation of the contract - prohibit further sale or further processing of the merchandise delivered, revoke automatic debit transfer according to figure IV. 5. and claim return of the merchandise on the buyer's costs or claim property of the merchandise without the buyer having a right of withholding or similar right. We are entitled to sell the merchandise returned by ourselves for counting against our receivables.
5. If we can we can claim for compensation because of non-fulfilment, our claim for compensation will at least be 20% of the price.

IV. Securities

1. All merchandise delivered (conditional commodity) will remain our property until all claims - especially the balance claim - which we are entitled to against the customer out of any legal reason, will have been fulfilled. This regulation is also applicable if payments on especially marked claims are effected.
2. Handling and processing of the conditional commodity is effected for us as manufacturer according to § 950 BGB (Bürgerliches Gesetzbuch) without any engagement from our side; the merchandise processed is considered to be conditional commodity. When processing, combining or blending/mixing conditional commodity by the customer, we are entitled to joint ownership on the new product in the proportion of the value of the conditional commodity to the value of the other applied merchandise. If our ownership lapses by combination or blend/mixture, the customer transfers to us already now the right of ownership on the new product in the extent of the value of the conditional commodity. The customer does not claim any fee. The rights of joint ownership which we are entitled to are to be considered as conditional commodity.
3. The customer is only allowed to sell conditional commodity in common trade and only if he is not in delay of payment, but with the proviso that the claims out of the resale are passed to us. The installation in real estate or in plants connected with buildings or the use in order to fulfil other works or works delivery contracts is equivalent to resale. If our customer concludes with his recipient of delivery an open account agreement, that does not let the claims for a resale immediately be contradictory to the contract, the claim resulting from the open account agreement in favour of the customer is already now considered to be transferred to us.
4. The claims of the customer resulting from the resale of our conditional commodity, wherein also the fulfilment of a works or works delivery contract is concluded, are already now transferred to us. If the conditional commodity is resold together with other products not delivered by us, the transfer of the claim resulting from the resale only amounts to the values mentioned in our invoice of the corresponding conditional commodity sold. When reselling merchandise which we have a right of joint ownership of, the transfer is in the amount of the joint ownership share. The transferred claims serve in the same degree as security as the conditional commodity.
5. The customer is entitled to call in claims resulting from a resale until the revocation admissible at any time. We will only use our right of revocation in the cases indicated in paragraph III. 4. The customer is not entitled to transfer the claims to third parties. On our demand, the customer is obliged to inform his buyers immediately of the transfer and to give us the necessary information and documentation for calling the claims in.
6. As far as there are claims of the customer against insurance or other third parties due to damage, deterioration, loss or sinking of the conditional commodity or due to other reasons, these claims are also transferred to us with all their subsidiary rights.
7. If we assert the reservation of title, this is considered as cancellation of contract only, if we express it in written form. The customer's right of possessing the conditional commodity lapses, if he does not fulfil his obligations of this or another contract. We are then entitled without extending the original term or without advice of cancellation, to take the conditional commodity in possession by ourselves and to utilize it without prejudice to the payment or other obligations of the customer towards us through selling it by private contract or by auctioning it off in the best possible way. The utilization revenue is charged to the customer after deduction of costs on his liabilities. Any possible surplus is paid out to him.
8. Any rights resulting from this reservation of ownership and all special forms fixed in these conditions are considered to be up to the moment of complete non-liability also contingent liabilities.
9. If the value of the securities of the secured claims passes continuously more than 20 %, we are obliged to unblock securities in so far upon our choice on the customer's demand.
10. We are always entitled to enter the business and plant rooms of the customer for establishing the existence of merchandise under reservation of ownership.

V. Place of performance, place of jurisdiction, applicable law, language of contract

1. Place of performance/fulfilment for both contracting parties is the site of our works of delivery.
2. Place of jurisdiction for both contracting parties is Bielefeld.
3. The law of the Federal Republic of Germany shall be applied. The standard laws on international sale of movable objects is not applicable.
4. The German version is binding in written documents.

valid from 01. July 2001

B. Execution of deliveries and performances

I. Acts of God and other hindrances

1. Events considered to be Acts of God authorize us to prolong delivery or performance for the time of hindrance plus an adequate period, or to withdraw in total or in parts from the contract due to the not yet fulfilled part. Equivalent to Acts of God are strike, lockout, mobilization, war, blockade, ban on exports and imports, lack of commodity and fuel, fire, roadblocks, disruptions in plant or transports and other circumstances, which we do not have to stand in for, no matter if they occur to us, to our in-supplier, or to one of your sub-deliverers.
2. If the customer has a right of withdrawal regarding the cases mentioned under '1.', the withdrawal can only be declared for the not yet fulfilled part of the contract; he is, however, obliged to replace the expenses accrued to us for the not yet fulfilled part of the contract against permitting the use of the processed and virgin materials.
3. The declaration of an in-supplier or sub-deliverer is a sufficient proof, that we are hindered to supply.

II. Periods of delivery and performance

1. Periods and deadlines are without engagement.
2. Periods begin with date of confirmation of the order, however not before complete clarification of all details and the transmission of possibly necessary declarations from authorities or others by the customer; deadlines are prolonged correspondingly. Periods and deadlines refer to the date of announcement of readiness to deliver ex works or ex stock.
3. Periods are prolonged – without prejudice to our rights of possible delay of the customer – for the period, while the customer does not fulfil his obligations out of this or another conclusion, in respect of our total planning.
4. In case of delay our customer is entitled to hand in his withdrawal after expiration of an adequately fixed extension of the original term of a fifth of the stipulated delivery period and/or performances, at least however ten working days.

III. Dispatch and passage of risk

1. We determine the forwarding agent or carrier. We choose transport-, protection- and dispatch means as way and manner of dispatch as well. The General German Forwarding Conditions (Allgemeine Deutsche Spediturbedingungen) are applicable for us as well.
2. Merchandise ready for dispatch on schedule have to be called off immediately. Otherwise we are allowed to stock them in our estimation on cost and risk of the customer and invoice them as delivered. The same is valid for the cases indicated below 'B.1'. At a charge-free delivery, the customer has to discharge the means of transport at once. Waiting periods are to be chargeable to the customer.
3. With transfer of the merchandise to the forwarding agent or carrier, at least when leaving our works, even if the merchandise is delivered with one of our heavy goods vehicle, the risk is passed over - even at a delivery free of charge – in every case – confiscation inclusive – to the customer. For further performance, especially assembly performances, the risk is passed over to the customer with progressing performance.
4. The customer is responsible for unloading and transport to the application or stocking site, he has to bear insofar costs and risk of discharging or stacking or stocking or re-transport in case of delay.

IV. Warranty

- We warrant – according to the approved rules of technology – faultless material and work. We are liable for possible imperfections of delivery or performance – lacking of assured qualities inclusive – to the exclusion of further claims as follows:
1. The warranty period for application parts and electronic equipment is 24 months, for drive systems for commercial use 12 months, calculated from the time of risk passage.
 2. Faults have to be complained in due course – recognizable faults within 5 days from arrival of the goods at their place of destination, otherwise possible claims will lapse.
 3. We are obliged to rectify faults on elements of our choice or to deliver them anew, which may be interfered on their serviceability within the period of warranty due to a circumstance lying in the passage or risk, or to reimburse the reduced value. Replaced elements become our property.
 4. If we do not fulfil our warranties, the customer has only a right of reduction of purchase price to the exclusion of further claims after mounting and insofar as the backing out is connected with unreasonable expense; otherwise he has a right of withdrawal, if the referral to the right of reduction of purchase price is unreasonable.
 5. The warranty does not extend to
 - a) faults resulting from natural depreciation, defective mounting and assembly work by third parties, faulty setting into operation, faulty or thoughtless treatment, improper use, as a consequent of outer influences (for instance magnetic fields) as well as non-respect of the operating instructions,
 - b) faults being caused by changes or repairs made without our prior consent by the customer or third parties,
 - c) delivered elements being subject to super-elevated natural abrasion due to their material or use, for instance sealings, plastics stocks.
 6. The customer has to give us an adequate occasion and an adequate period of time to carry out warranty actions; otherwise possible claims will lapse. If the contractual object is used in spite of the defect, the warranty is restricted only to the original defect.
 7. The warranty is 6 months for the replacement and/or rectification, at least however the original warranty period.
 8. We are allowed to refuse the removal of faults as long as the customer does not fulfil his obligations in an adequate extent.
 9. Warranty claims will lapse after one month after our refusal or rejection of our proposed solution, calculated from the date of our letter.
 10. In negotiations on formal complaints, we do not renounce on the objection, that a complaint has not been made in time or sufficiently. Persons charged with the verification of a customer's complaint are not entitled to approve faults with effect against ourselves.
 11. Other claims are - as far as admissible – excluded; this applies especially for claims for compensation of damages, that did not arise on the contractual object itself.
 12. The above-mentioned provisions will also be applied for the delivery of other non-contractual merchandise.

C. I. Liability

Our liability refers exclusively to the agreements made in the paragraphs above. All other claims not expressly granted therein (compensation for damages) – no matter out of which legal reason – are, as far as admissible – excluded, as long as not solely restricted to the compensation of damages on the delivered object and on the whole limited to 65% of the delivery and performance value, and they will become time-barred six months from date of passage of risk.

II. Partial invalidity

In case conditional parts are invalid – due to legal provisions and especially due to the law for regulation of the law of the General Terms and Conditions (Allgemeine Geschäftsbedingungen – AGB-Gesetz), we agree that invalid conditional parts affected insofar will be replaced by the legally admissible regulation. This applies especially for contracts with non-traders.

III. No support of third parties, interdict of assignment

This contract does not found rights for third parties. An assignment of claims and rights out of this contract by the customer requires our written consent.

IV. Right of admission for control personnel

The customer is obliged to take care of the admission of control personnel which is charged to verify grade-labelled products.

Assembly conditions (are applied in connection with our Sales Conditions and Terms of Delivery).

Marantec
Antriebs- und Steuerungstechnik
GmbH & Co KG
Remser Brook 11
D 33428 Marienfeld

